

LED HIGH BAYS
85W
5000K 11768lm



Dimmable as standard

IES Data Files available

DIMENSIONS

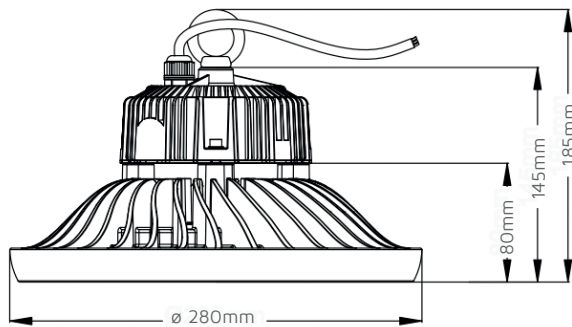

COMPATIBLE ACCESSORIES

High Bay Suspension Kit	NET-46-16-06	Page 229
Reflector 90 Degree	NET-23-16-01	Page 179
Bracket Set 85/120/200W	NET-23-16-07	Page 179
Merrytek IP65 Dimming Sensor	NET-42-43-08	Page 214
Microwave Sensor plate	NET-23-16-09	Page 180

KEY DATA

Power	85W
Luminous Flux	11768lm
Colour Temperature	5000K
IP Rating	IP65
IK Rating	IK08
Dimensions	ø 280 x 143mm
Warranty	5 Years Extended

Part Number

NET-23-12-11

TECHNICAL SPECIFICATIONS

Input Voltage AC	100-240V
Power Factor	>0.97
LED Luminous Flux	12360lm
Luminous Efficacy	138lm/W
LED Manufacturer	Philips
LED Type	SMD3030
No. of LEDs	140
Driver Manufacturer	Tomcarline
Driver Output Voltage DC	36-48V
Total Circuit Power (W)	85W +/-5W
Electrical Class	1
Colour Rendering	>70
Lamp Viewing Angle	110°
Dimmable	1-10v As Standard
Operating Temp.	-15°C to +45°C
Lifespan	50.000 Hours
Fire Rating	V-1
UGR Rating	<25
Diffuser Material	Glass
Housing Material	Aluminum
Housing Colour	Black
Weight	3.5Kg

TYPICALLY REPLACES

- 250W/400W metal halide.
- 250W/ 400W SON.

FEATURES & BENEFITS

- Highly efficient heat sink.
- Suspension ring for easy installation.
- 1m flex.
- Dimmable Driver as standard.
- Suitable for High Bay installation with optional narrow beam angle reflector.
- Suitable for Low Bay installation with wide beam angle.
- Mounting bracket available for ceiling mount.
- Compatible with Merrytek Daylight Sensor and IP65 Microwave Sensor.
- Compliant with EN 60598-2-1.