

### Safety Information

>All electrical work must be undertaken by a qualified contractor to ensure compliance with latest edition BS 7671 and IEE/IET wiring regulations.

> Before installing an LED IP54 2D Emergency Bulkhead or doing any maintenance, ensure power supply is turned off at the circuit breaker or fuse box.

> This product is designed for permanent connection to fixed wiring; the circuit should be protected with the appropriate MCB or fuse.

### Environment

> Please DO NOT dispose of electrical items or packaging as unsorted waste. Use the recycling facilities provided by your local authorities.

### PRODUCT DIMENSIONS

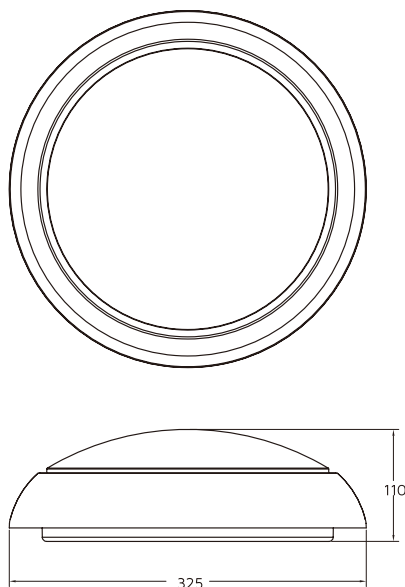

All units are in mm

### Important Warranty Information

The LED IP54 2D Emergency Bulkhead circuitry has a 3 year warranty (Battery 1 year). To claim, you must provide the product part number and date of manufacture, which can be found on the label attached to the luminaire housing along with the original purchase invoice.



theLIA

MEMBER



ISO 9001:2008  
FS 590684



ISO 9001:2004  
EMS 590685

NET LED Limited  
Buckingham Business Park  
300 Anderson Road  
Cambridge  
CB24 4UQ UK  
sales@netled.co.uk  
www.netled.co.uk

Technical Helpline: 01223 851505  
Email: support@netled.co.uk

Drawing No: NET-11-06-85-IG\_V2  
www.netled.co.uk/downloads

Distributed by



LED IP54 2D  
EMERGENCY BULKHEAD  
INSTALLATION GUIDE

NET-11-06-85

### KEY DATA

Light Source	LED
Power	16W
Luminous Flux	1100lm
Luminous Efficacy	>72lm/W
Colour Temperature	4000K
Colour Rendering	>80 CRI
Housing Material	ABS
Diffuser Material	Polycarbonate
IP Rating	IP54
Manufacturer	Toppo Lighting Co



### SUPPLY/EARTH CLASS

220-240V AC 50/60 Hz



Class I

Fig.1 Mains Input Termination

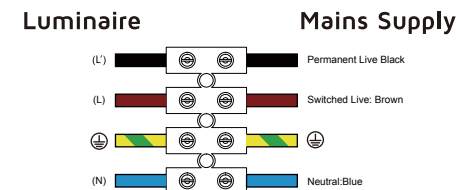

**Installation procedure:** Carefully read the installation instructions and ensure the mains supply is isolated before installation. Please read the safety information overleaf before carrying out any installation. Please retain this leaflet for future reference.

## 2D Bulkhead Installation

**Step 1:** Hold down the LED IP54 2D Bulkhead Emergency and rotate the diffuser anti-clockwise to remove it.

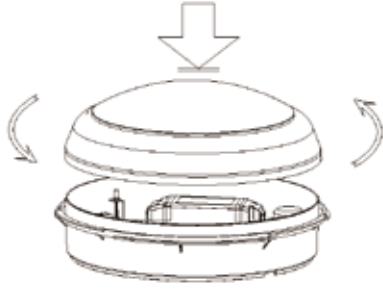

**Step 3:** Unscrew and remove the terminal box lid. Wire the Gear Tray as per Wiring Diagram 1.



**Step 2:** Remove the Gear Tray from the Gear Tray housing. Drill out the screw holes in the housing and screw it onto a solid surface using suitable wall plugs and screws.

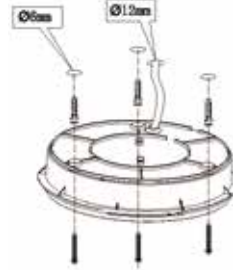

**Step 4:** Finally, re-insert the Gear Tray into the Gear Tray housing and secure the power cable. Re-fit the diffuser by aligning it with the gear tray housing and rotate it clockwise. Switch on the mains supply to test the fitting.

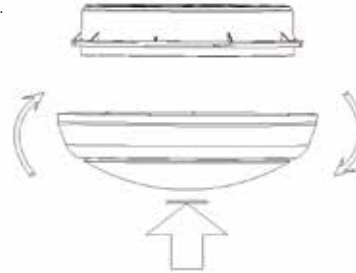

## Wiring Diagram 1

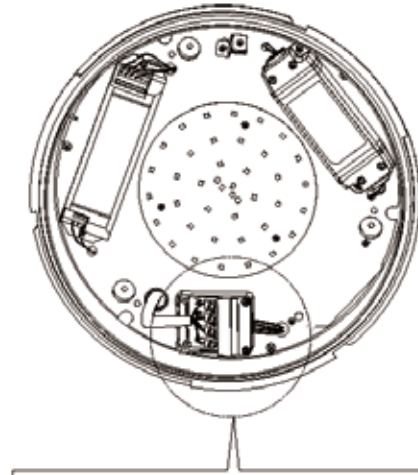

**Note:** A qualified electrician is required to carry out the electrical wiring.

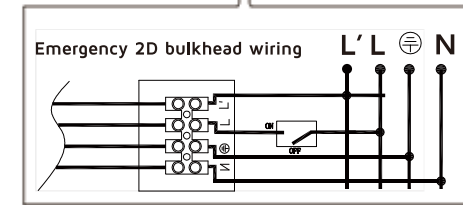

Other products from NET LED Lighting Full range available at [www.netled.co.uk](http://www.netled.co.uk).

### LED Downlights

LED Downlights are low energy replacement for CFL and PLL fittings to use in a wide range of applications.



Available in:  
4", 6" and 8" versions.

### LED Panels

LED Panels are versatile and reliable, specifically designed to sit in most standard ceiling grids.



Available in:  
500X500mm, 600X600mm,  
1200X300mm and 1200X600mm  
versions.

### LED NCF Luminaires

Robust units incorporating advanced chip technology and Philips driver in all-polycarbonate IP65 housings.



Available in:  
2ft, 4ft and 5ft versions.

### LED Slimline Flood Lights

IP66 rated units perfect for use in warehouses, above doors and shutters, security or signage lighting.



Available in:  
10W, 30W, 50W, 80W  
and 100W versions with  
optional PIR and Photocell  
attachments.