

Safety Information

>All electrical work must be undertaken by a qualified contractor to ensure compliance with latest edition BS 7671 and IEE/IET wiring regulations.

> Before installing a Kingston LED UGR<19 Tri-Colour Panel Light or doing any maintenance, ensure power supply is turned off at the circuit breaker or fuse box.

> This product is designed for permanent connection to fixed wiring; the circuit should be protected with the appropriate MCB or fuse.

Environment

> Please DO NOT dispose of electrical items or packaging as unsorted waste, use the recycling facilities provided by your local authorities.

PRODUCT DIMENSIONS

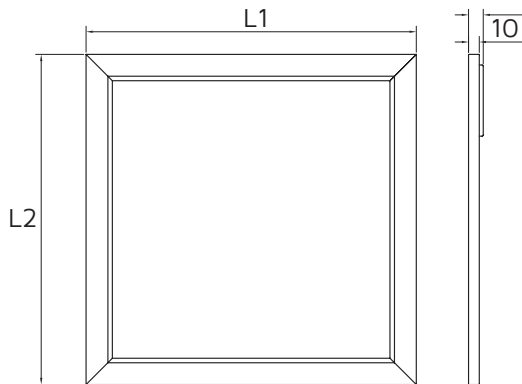

Size(mm x mm)	L1	L2
595x595	595	595
1195x595	1195	595

All units are in mm

Important Warranty Information

The Kingston LED UGR<19 Tri-Colour Panel Light has a 3 year warranty, which can be extended free of charge to 5 years by registering online via the website address below. The registrant must provide the product part number and date of manufacture, which can be found on the label attached to the luminaire housing.



ISO 9001:2008
FS 590684



ISO 9001:2004
EMS 590685

NET LED Ltd.
Buckingway Business Park
300 Anderson Road
Cambridge
CB24 4UQ
sales@netled.co.uk
www.netled.co.uk

Technical Helpline: 01223 851505
Email: support@netled.co.uk

Drawing No: NET-11-03-P-IG_V1
www.netled.co.uk/downloads

Distributed by



LED PANEL INSTALLATION GUIDE

LED PANEL NET-11-03-06/08

KEY DATA

Light Source:	LED	
Size (mm)	600X600	1200X600
Power	32W	55W
Luminous Flux (3000K)	3150lm	6020lm
Luminous Flux (4000K)	3400lm	6480lm
Luminous Flux (5500K)	3230lm	6250lm
Luminous Efficacy	140lm/W	
Colour Temperature	Tri-Colour 3000, 4000, 5500K	
Colour Rendering	>80 CRI	
Housing Material	Aluminium	
Diffuser/LGP Material	Polycarbonate/PMMA	
IP Rating	IP40	
Manufacturer	Toppo Lighting Co	

SUPPLY/EARTH CLASS

Driver
220-240V AC 50/60 Hz
Fig.1 Mains Input Termination

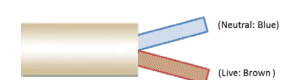

Luminaire
36-42V DC
Fig.2. Twist Lock Connectors



Installation procedure: Carefully read the installation instructions and ensure the mains supply is isolated before installation. Please follow the safety information overleaf before carrying out any installation. Please retain this leaflet for future reference. **Important:** When installing, leave a space of at least 1.2m between the LED Panel and any heating source/air conditioning unit.

LED Panel Installation:

Step 1: Carefully remove the LED Panel and driver from the packaging. Remove the ceiling tile from the location where you want to install the LED Panel.

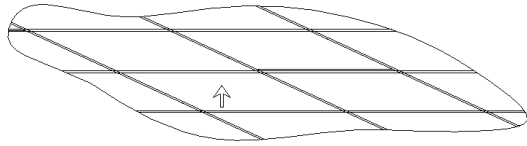

Fig.3

Step 2: Using the mounting bracket available on the back of the LED Panel, securely mount the LED Driver, Fig.4a. Connect the LED Driver using interlocking power connectors, Fig.4b.

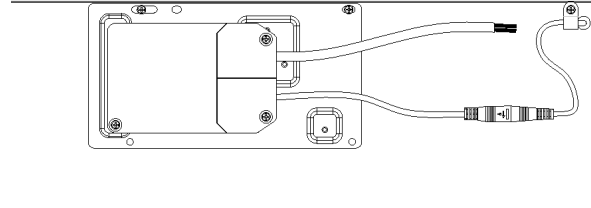

Fig.4a

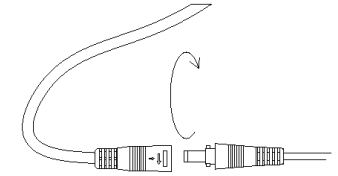

Fig.4b

Step 3: Wire the flying leads from the LED Driver into the mains supply

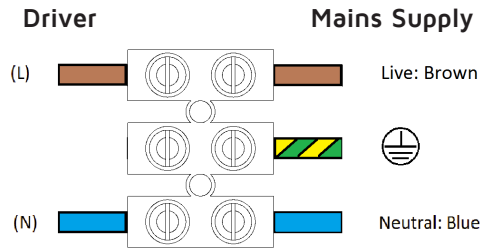

Fig.5

Step 4: Move LED Panel into the ceiling aperture and ensure the LED Panel is mounted securely, Fig.6a. Finally, turn on the mains supply to check the panel is working correctly, Fig.6b.

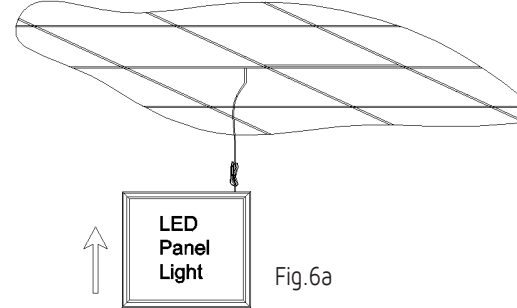

Fig.6a

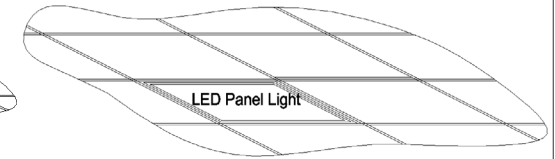

Fig.6b

Optional additional products: A number of additional mounting options are also available.

Suspension Kits

Wire suspension kits for LED Panels provide various installation options by allowing them to be suspended from higher or angled ceilings.



Surface Mount Boxes

Surface Mount Boxes provide a slim option to mount Panels on a surface that has no void behind it. The void in the box allows sufficient space for a driver and 3 Hour Emergency Kit.

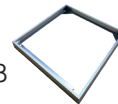

3 Hour Emergency Kits

LED Panel Lights are compatible with our 3 Hour Emergency Kits. Units maintain compatible Panels for 3 hours at not less than 3W.



Dimming accessories

We supply DALI, Push and 1-10V dimming accessories specially calibrated for use with our LED Panel Lights.



Full specifications are available on request or at www.netled.co.uk.