

Safety Information

>All electrical work must be undertaken by a qualified contractor to ensure compliance with latest edition BS 7671 and IEE/IET wiring regulations.

> Before installing an LED 2D Emergency Bulkhead or doing any maintenance, ensure power supply is turned off at the circuit breaker or fuse box.

> This product is designed for permanent connection to fixed wiring; the circuit should be protected with the appropriate MCB or fuse.

Environment

> Please DO NOT dispose of electrical items or packaging as unsorted waste. Use the recycling facilities provided by your local authorities.

PRODUCT DIMENSIONS

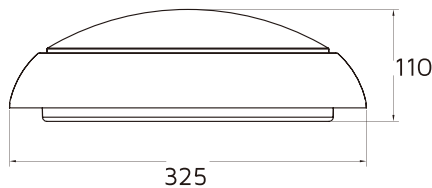
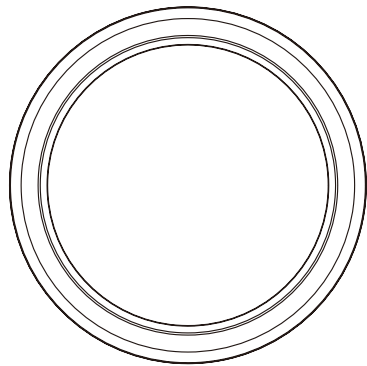

All units are in mm

Important Warranty Information

The LED 2D Emergency Bulkhead circuitry has a 3 year warranty (Battery 1 year). To claim, you must provide the product part number and date of manufacture, which can be found on the label attached to the luminaire housing along with the original purchase invoice.

Manufactured in China by
Toppo Co. Ltd.
NET-11-06-XX

This luminaire contains built-in LED lamps.

LED

The lamps cannot be changed in the luminaire.

874/2012



theLIA
MEMBER



NET LED Limited
Buckingway Business Park
300 Anderson Road
Cambridge
CB24 4UQ UK
sales@netled.co.uk
www.netled.co.uk

Technical Helpline: 01223 851505
Email: support@netled.co.uk

Drawing No: NET-11-06-EM-IG_V2
www.netled.co.uk/downloads

Distributed by



LED 2D EM BULKHEAD INSTALLATION GUIDE

LED 2D EM BULKHEAD NET-11-06-XX

KEY DATA



Light Source	LED
Power	16W
Luminous Flux (3000K)	1250lm
Luminous Flux (4000K)	1450lm
Luminous Flux (5500K)	1250lm
Luminous Efficacy	>80lm/W
Colour Temperature	Tri-Colour 3000K/4000K/5500K
Colour Rendering	>80 CRI
Housing Material	Polycarbonate
Diffuser Material	Polycarbonate
IP Rating	IP54
Manufacturer	Toppo Lighting Co

SUPPLY/EARTH CLASS

220-240V AC 50/60 Hz



Fig.1 Mains Input Termination

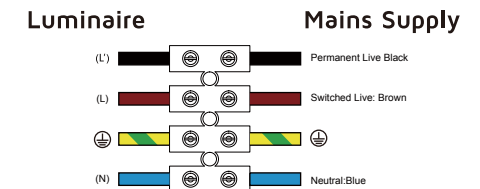

Installation procedure: Carefully read the installation instructions and ensure the mains supply is isolated before installation. Please read the safety information overleaf before carrying out any installation. Please retain this leaflet for future reference. For emergency functions and battery maintenance please refer to the emergency test record sheet enclosed with the fitting.

2D Emergency Bulkhead installation:

Step 1: Hold down the 2D Emergency Bulkhead and rotate the diffuser anti-clockwise to remove it.

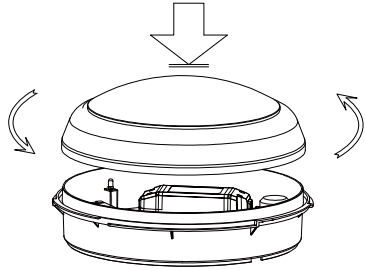

Step 2: Remove the Gear Tray from the housing by loosening the quick release screws. Drill out the screw holes in the housing and screw it into a solid surface using suitable wall plugs and screws.

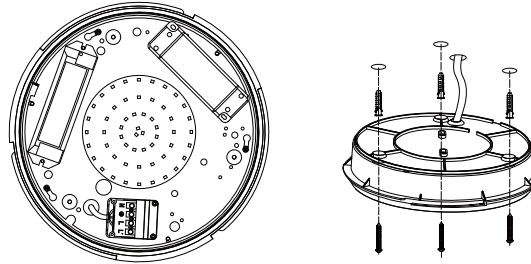

Step 3: Unscrew and remove the terminal box lid. Wire the Gear Tray as per the diagram below.

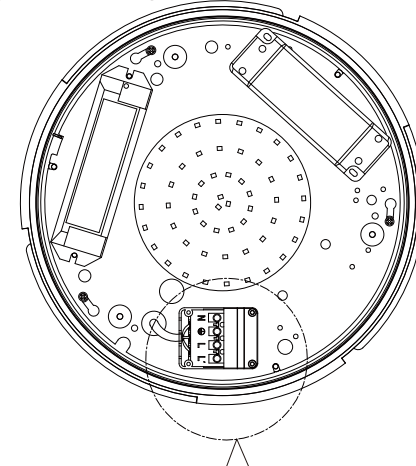

Note: A qualified electrician is required to carry out the electrical wiring.

Step 4: Re-insert the Gear Tray into the housing and secure the power cable. Select colour temperature on the PCB switch and set up motion sensor if fitted.

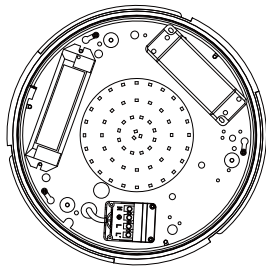

Step 5: Replace the diffuser by aligning it with the Gear Tray housing and rotate it clockwise. Switch on the mains supply.

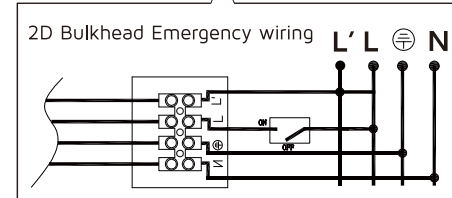
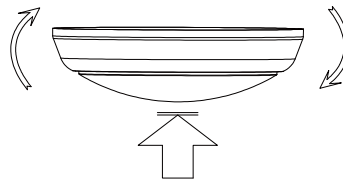

Microwave Motion Sensor configuration - These settings apply only to the 2D Bulkheads with Microwave Motion Sensor option.



Detection Area			Full Brightness Hold Time		Daylight Sensor			10% Corridor Function Time			
ch1	ON	100%	ch3	ON	5S	ch5	ON	Disable	ch7	ON	Off/0s
ch2	ON		ch4	ON		ch6	ON		ch8	ON	
ch1	OFF	75%	ch3	OFF	90S	ch5	OFF	50Lux	ch7	OFF	30s
ch2	ON		ch4	ON		ch6	ON		ch8	ON	
ch1	ON	50%	ch3	ON	3min	ch5	ON	15Lux	ch7	ON	10min
ch2	OFF		ch4	OFF		ch6	OFF		ch8	OFF	
ch1	OFF	25%	ch3	OFF	10min	ch5	OFF	5Lux	ch7	OFF	Always On/+∞
ch2	OFF		ch4	OFF		ch6	OFF		ch8	OFF	

*Default Set Up On Delivery