

Safety Information

> All electrical work must be undertaken by a qualified contractor to ensure compliance with latest edition BS 7671 and IEE/IET wiring regulations.

> Before installing an LED Flood Light or doing any maintenance, ensure power supply is turned off at the circuit breaker or fuse box.

> This product is designed for permanent connection to fixed wiring; the circuit should be protected with the appropriate MCB or fuse.

Environment

> Please DO NOT dispose of electrical items or packaging as unsorted waste. Use the recycling facilities provided by your local authorities.

PRODUCT DIMENSIONS

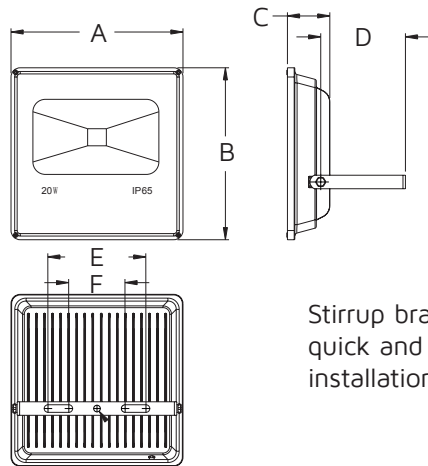

Stirrup bracket for quick and simple installation

Floodlight	A	B	C	D	E	F
20W	183	179	40	79	114	79
40W	226	221	52	85	120	65
60W	283	273	60	95	163	112

All units are in mm

Important Warranty Information

The LED Flood Light has a 2 year warranty. To claim, you must provide the product part number and date of manufacture, which can be found on the label attached to the luminaire housing along with the original purchase invoice.



theLIA
MEMBER



NET LED Ltd.
Buckingway Business Park
300 Anderson Road
Cambridge
CB24 4UQ
sales@netled.co.uk
www.netled.co.uk

Technical Helpline: 01223 851505
Email: support@netled.co.uk

Drawing No: NET-15-04-BF-IG_V1
www.netled.co.uk/downloads

Distributed by



LED FLOOD LIGHT INSTALLATION GUIDE

LED FLOOD LIGHT NET-15-04-8X

KEY DATA

Light Source	LED		
Power	20W	40W	60W
Luminous Flux	2000lm	3300lm	5400lm
Luminous Efficacy	>110lm/W		
Colour Temperature	4000K		
Colour Rendering	>75 CRI		
Housing Material	Aluminium		
Diffuser Material	Glass		
IP Rating	IP66		
Manufacturer	Leyond		



SUPPLY/EARTH CLASS

200-240V AC 50/60 Hz



Class I

Fig.1 Mains Input Termination

Luminaire

Mains Supply

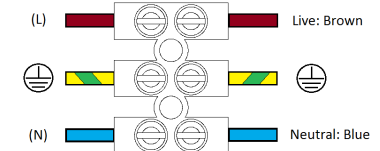

Installation procedure: Carefully read the installation instructions and ensure the mains supply is isolated before installation. Please read the safety information overleaf before carrying out any installation. Please retain this leaflet for future reference.

Flood Light Installation:

Step 1: Carefully remove the LED Flood Light from the packaging. Loosen the bolts on each side of the LED Flood Light and remove the mounting bracket.

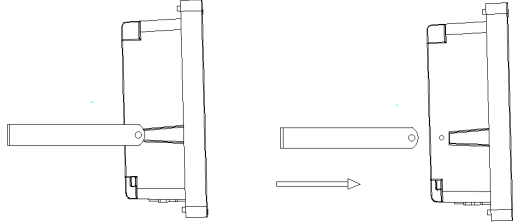

Step 2: Select a suitable mounting position and refer to the table below for the minimum recommended mounting height. Drill into the mounting surface and screw the bracket onto the mounting surface using suitable wall plugs and screws.

Power	Minimum Mounting Height
20W	2m
40W	2m
60W	2m

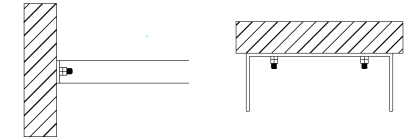

Step 3: Re-attach the Flood Light to the bracket.

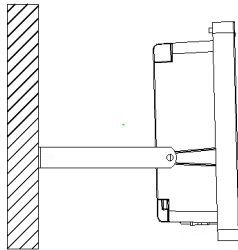

Step 4: Tilt the Flood Light to adjust it as required and tighten the bolts to lock the Slimline Flood Light in position.

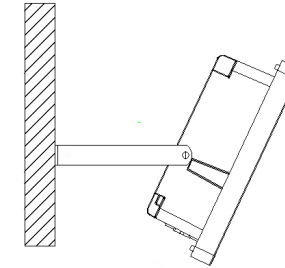

Step 5: Secure the supply cable to the wall using suitable clips. Ensure that the cable is not touching the body of the Flood Light.

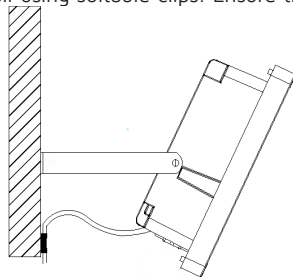

Step 6: Connect the cable to the mains as per the illustration below and test the LED Flood Light for correct operation.

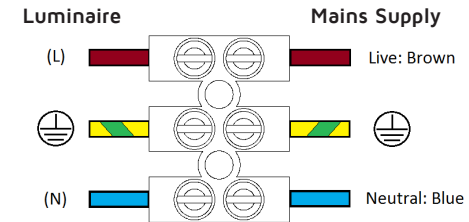

LED High Bays

A range perfect for use in warehouses, factories, gyms, airports and anywhere with high ceilings that requires a high level of focused light.



LED High Power Flood Light

A series of versatile, IP65 rated units for outdoor applications, ranging from 100W to 250W.

5 Year Extended Warranty.



LED Slimline Flood Light

Available in 10W, 30W, 50W, 80W and 100W, the Slimline range is a more compact unit compatible with optional PIR and Photocell attachments.



Other Products

See www.netled.co.uk for more commercial LED lighting products, including Downlights, Panels, T5 and T8 Tubes, 2D Bulkheads and retrofit Gear Trays, Non-Corrosive Luminaires and much more.