

Safety Information

>All electrical work must be undertaken by a qualified contractor to ensure compliance with latest edition BS 7671 and IEE/IET wiring regulations.

> Before installing an LED Tri-Colour Downlight or doing any maintenance, ensure power supply is turned off at the circuit breaker or fuse box.

> This product is designed for permanent connection to fixed wiring; the circuit should be protected with the appropriate MCB or fuse.

Environment

> Please DO NOT dispose of electrical items or packaging as unsorted waste. Use the recycling facilities provided by your local authorities.

PRODUCT DIMENSIONS

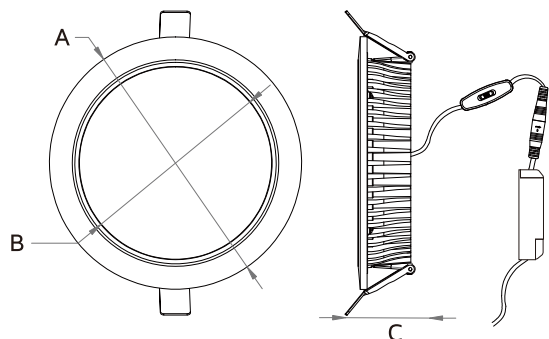

Size(Inch)	A	B	C
4	135mm	89mm	57mm
6	195mm	129mm	69mm
8	225mm	163mm	73mm

Important Warranty Information

The Tri-Colour Downlight has a 3 year warranty, which can be extended free of charge to 5 years by registering online via the website address below. The registrant must provide the product part number and date of manufacture, which can be found on the label attached to the luminaire housing.



theLIA

MEMBER



ISO 9001:2008
FS 590684



ISO 9001:2004
EMS 590685

NET LED Limited
Buckingham Business Park
300 Anderson Road
Cambridge
CB24 4UQ UK
sales@netled.co.uk
www.netled.co.uk

Technical Helpline: 01223 851505
Email: support@netled.co.uk

Drawing No: NET-11-05-7X-IG_V2
www.netled.co.uk/downloads

Distributed by



LED TRI-COLOUR DOWNLIGHT INSTALLATION GUIDE

LED DOWNLIGHT NET-11-05-7X

KEY DATA

Light Source	LED 		
Size	4"	6"	8"
Power	7W	16W	20W
Luminous Flux (3000K)	710	1690	2100
Luminous Flux (4000K)	730	1770	2190
Luminous Flux (5500K)	720	1720	2130
Luminous Efficacy	>100lm/W		
Colour Temperature	Tricolour 3000K,4000K and 5500K		
Colour Rendering	>80 CRI		
Housing Material	Aluminium		
Diffuser Material	Polycarbonate		
IP Rating (Front/Back)	IP65/20		
Manufacturer	Toppo Lighting		

SUPPLY/EARTH CLASS

Driver
220-240V AC 50/60 Hz
Fig.1 Mains Input Termination

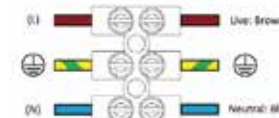

Luminaire
36-42V DC
Fig2. Twist Lock Connectors



Installation procedure: Carefully read the installation instructions and ensure the mains supply is isolated before installation. Please read the safety information overleaf before carrying out any installation. Please retain this leaflet for future reference.

LED Downlight Installation:

Step 1: Isolate mains power supply before starting any installation. Cut out a mounting hole in the ceiling as per the dimensions in the table below.

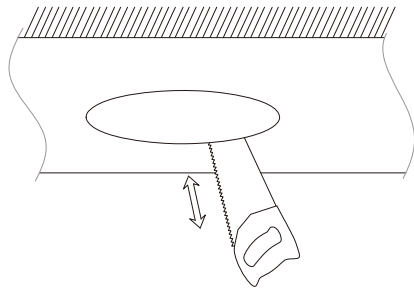

Downlight	Cut-out
4 Inch	120-125mm
6 Inch	170-175mm
8 Inch	200-205mm

Step 2: Connect the Downlight and driver using the inter-locking connectors. Wire the LED driver to the mains supply junction box.

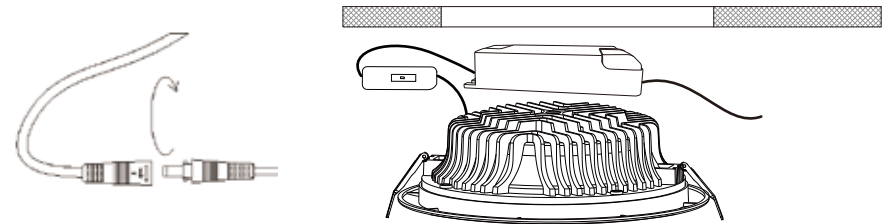

Step 3: Press clasping springs back and push downlight body into the aperture until it's fixed in the ceiling.

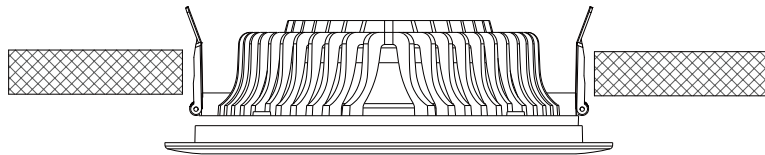

Step 4: Switch on the mains supply to test the Downlight for correct operation.

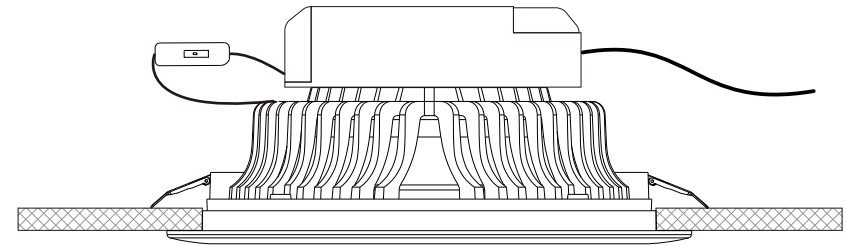

Optional additional products: A number of additional compatible products are available.

Other products from NET LED Lighting Full range available at www.netled.co.uk.

3 Hour Emergency Kits

LED Downlights are compatible with our 3 Hour Emergency Kits. Units maintain compatible Downlights



Full specifications are available on request or at www.netled.co.uk.

Dimming accessories

We can supply DALI and 1-10V dimming accessories.



Full specifications are available on request or at www.netled.co.uk.

LED NCF Luminaires

Robust units incorporating advanced chip technology and Philips driver in all-polycarbonate IP65 housings.



Available in 2ft, 4ft and 5ft versions.

LED Slimline Flood Lights

IP66 rated units perfect for use in warehouses, above doors and shutters, security or signage lighting.



Available in 10W, 30W, 50W, 80W and 100W versions with optional PIR and Photocell attachments.